



*An Online CPD Course  
brought to you by  
CEDengineering.ca*

# **Basic Principles of Metallurgy and Metalworking**

Course No: T04-009

Credit: 4 PDH

---

Donald Parnell, P.E.

---

**CE****D** **CANADA**  
engineering.ca  
CPD FOR THE PROFESSIONAL

Continuing Education and Development, Inc.

P: (877) 322-5800

[info@cedengineering.ca](mailto:info@cedengineering.ca)

[www.cedengineering.ca](http://www.cedengineering.ca)



# Basic Principles of Metallurgy and Metalworking

## Table of Contents

Chapter 1: History of Metalwork and Metallurgy

Chapter 2: Ore and Metallurgical Processing

Chapter 3: Metal Properties and Alloys

Chapter 4: Mechanical Properties of Metals

Chapter 5: Strength in Metals

Chapter 6: Corrosion Resistance

Chapter 7: Types of Iron (Ferrous Metals)

Chapter 8: Types of Steel (Another Ferrous Metal)

Chapter 9: Nonferrous Metals and Alloys

Chapter 10: Metalworking Processes

Chapter 11: Metal Identification And Testing Methods

# Chapter 1: History of Metalwork and Metallurgy

## Metals and temperature

Throughout history, advances in metalworking correlated with advances in achieving the higher temperatures in our melting of those metals. As we developed the means to achieve higher temperatures in the melting and smelting processes, so too did we advance in our metalworking and alloying technologies.

Those ores and metals that could be smelted and melted at lower temperatures were the first to be developed into the weaponry, tools, and jewelry of the day.

Metals with lower melting points such as copper, and its alloy bronze, were discovered long before iron and its alloy steel. Also, the pure metals, like copper and iron, were used before their alloys, bronze and steel.

## Metals found in ancient history

*Ancient civilizations knew of seven metals:*

- Iron
- Tin
- Lead
- Copper
- Mercury
- Silver
- Gold

Not all metal required heat in order to be processed. Gold, by its chemistry was found in nature already in workable form.

There are a few other metals that can occur natively, though almost all other metals are found in ore, a mineral-bearing rock, that requires heating or other processes to liberate the metal.

Gold, workable as it is found, required no technology beyond a stone hammer and anvil to work the metal. This is a result of gold's properties of malleability and ductility. The earliest tools were stone, bone, wood, and sinew, all of which were more than adequate to work gold nuggets straight from the earth.

## **The Copper Age (from 8700 BC)**

## **Circa 8700 BC – The age of copper**

In the Copper age, (aka Chalcolithic, Aeneolithic, or Eneolithic period; regarded as a part of the broader Neolithic or “New Stone Age”), copper predominated in metalworking technology.

Copper was used by humans for over 10,000 years with evidence of its use being found recently in what is now Northern Iraq.

Ancient cultures of Mesopotamia, Egypt, Greece, Rome, Indus and China all used copper to develop weapons for war. The ancient Sumerians were some of the first people to utilize copper for this purpose.



## Neolithic metallurgical processes

Four metallurgical techniques appeared more or less simultaneously at the beginning of the Neolithic Age, around 7500 BC.

*They included:*

- Cold working
- Annealing
- Smelting
- Lost wax casting\*

*\*Investment casting is a modern day industrial process based on the lost-wax casting method used for making accurate castings from a mold, produced around a wax pattern or similar type of material. The “lost wax” melts away during the casting process.*

## 4000 BC – The use of mining for copper ore

The first European copper miners are believed to have come from the Balkan region (see image). Using bone tools to excavate the ore, they were able to extract large amounts of copper ore from the Rudna Glava (or Ore Head) in what is now present day Serbia.

The miners at this time were primarily agrarian, concerned in animal husbandry, hunting and foraging, descended from the Neolithic Vinča culture that had survived from the period of civilization which existed between 5700–4500 BC.



## **The Bronze Age (from 4500 BC)**

## **4500 BC - Bronze**

In creating bronze, non-metals such as arsenic, silicon and phosphorus were added to the copper mix. Tin was later used to make bronze in Serbia. The tin bronze was far superior to the arsenic bronze and was easier to work, stronger and less toxic.

### **Uses for bronze**

Being more robust than copper or stone, bronze enabled people to create more durable metal objects such as tools, art, weapons, currency and building materials.

In the day, more durable tools and weaponry meant stronger armies, and quicker technological advancement for those civilizations which had perfected the metalworking processes, beyond those of their rivals.

## Historical vs. modern bronze

**Historical bronzes** - may have contained a mixture of copper, lead, nickel, tin, iron, antimony, arsenic and a large amount of silver; this could suggest that hoards of coins were used in the creation of certain items.

**Modern day bronze** - is an alloy created using many different metals like aluminum, nickel and zinc. A modern bronze alloy may be 88% copper to 12% tin. A bronze alloy used in springs, turbines and blades is typically only 5% tin. Commercial bronze is a mixture of 90% copper to 10% zinc. Bronze used for architectural applications is only 57% copper to 40% zinc and 3% lead.

# The Iron Age (from 1500 BC)

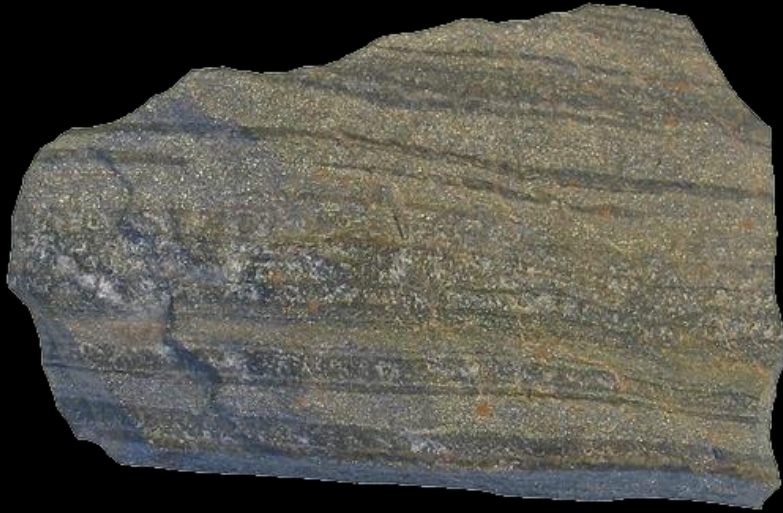

## **The age of iron: from 1500 BC**

The next great development in metallurgy involved the pure metal, iron, which is the most abundant in the earth's surface but which is far more difficult to work than copper or tin.

Iron had a melting point which was too high for primitive furnaces to extract in pure form from its ore (image shows a banded iron formation).

## Use of iron prior to 1500 BC

Prior to the use of higher temperature furnaces, the best that could have been achieved was a cluster of globules of iron mixed with a sludge of impurities. This could've eventually been turned into a useful metal through the repeated process of heating and hammering, until the impurities were eventually worked out of the mixture.

A few iron objects dating from before 2000 BC have been found (beads, a ring, some blades), but it is not until circa 1500 BC that the working of iron becomes commonplace.

In this simpler form, iron was softer than bronze, and therefore was originally of limited use for weaponry and tool development.



## **The Discovery of Steel (circa 1100 BC)**

## **Discovery of steel: 11th century BC**

By the 11th century BC, it had been discovered that iron could be much improved. When reheated in a furnace with charcoal (containing carbon), some of the carbon was transferred to the iron.

This process hardens the metal; and the effect was considerably greater if the hot metal was quickly cooled through quenching in a water bath.

The new material, steel could be worked (or 'wrought') just like softer iron, in order to retain a finer edge, capable of being honed to sharpness.

Gradually, from the 11th century onwards, steel replaced bronze weaponry in the Middle East, birthplace of the Iron Age.

# The Emergence of Cast Iron

## **Cast iron in the east: 513 BC**

Until circa 500 BC, iron had been heated and hammered, but never melted. Its melting point (1528°C) was far too high for primitive furnaces, which could reach around 1300°C .

This temperature was adequate for pure metals such as copper (melting at 1083°C), but not high enough to allow for iron metalworking processes.

The Chinese were the first to develop a furnace which was hot enough to melt iron, enabling them to produce the world's first cast iron, dating to circa 513 BC.

The western world took centuries to make similar discoveries in casting iron, with the first iron foundry in England, dating to around 1161 AD.

## **Chapter 2: Ore and Metallurgical Processing**

# Metallurgy

## **What is Metallurgy?**

Metallurgy is a domain of materials science and engineering that studies the physical and chemical behavior of metallic elements, their inter-metallic compounds, and their mixtures, known as alloys.

## **Metal technology**

Metallurgy is also the technology of metals: the way in which science is applied to the production and industrialization of metals, and the engineering of metal components for use in products for consumers and manufacturers.



## **Chemical metallurgy**

The scientific approach to metallurgy involves chemical and physical metallurgy.

Chemical metallurgy deals with the domain of the reduction and oxidation of metals.

It is the science of obtaining metals from their ores, and of the consideration of the reactions of metals derived through a chemical approach.

It involves the reactivity of metals, which includes the science of electrochemical (electrochemistry deals with the interaction between electrical energy and chemical change ), and corrosive behaviors within metals.

## Physical metallurgy

Physical metallurgy involves the mechanical, magnetic, electrical, and thermal properties of metals evaluated through the discipline of solid state physics (the study of rigid matter, or solids, by methods such as quantum mechanics, crystallography, electromagnetism, and metallurgy.)

Physical metallurgy is a systematic way of evaluating the physical properties of metals and alloys, and is basically the fundamental applications of the theory of *phase transformation* within metallic and alloyed substances.

## **Extractive metallurgy**

Extractive metallurgy is a branch of metallurgical engineering where the processes and methods of the extraction of metals from their natural mineral deposits are studied.

The field of ferrous and non-ferrous extractive metallurgy have specialties that are generically grouped into the categories, which are based on the process adopted to extract the metal:

- Mineral processing
- Hydrometallurgy
- Pyrometallurgy
- Electrometallurgy

Several processes can be used for the extraction of a given metal, depending on where that metal occurs naturally, and its chemical requirements.

## Mineral processing

This begins with beneficiation\*, consisting of initially breaking down the ore to required sizes depending on the concentration process to be followed, by crushing, grinding, sieving etc.

Thereafter, the ore is physically separated from any unwanted impurity, depending on the form of occurrence and/or further process involved. Separation processes take advantage of physical properties of the materials.

These physical properties can include density, particle size and shape, electrical and magnetic properties, and surface properties.

*\*Beneficiation is any process that improves or benefits the economic value of the ore by removing the gangue (or commercially worthless material) that surrounds the mineral, thus resulting in a higher grade product (concentrate) and a waste stream (tailings). Examples of beneficiation processes include froth flotation and gravity separation.*

## Mineral processing (continued)

Major physical and chemical methods include magnetic separation, froth flotation, leaching etc., whereby the impurities and unwanted materials are removed from the ore and the base ore of the metal is concentrated, meaning the percentage of metal in the ore is increased.

This concentrate is then either processed to remove moisture or else used as is for extraction of the metal or made into shapes and forms that can undergo further processing, with ease of handling.

Ore bodies often contain more than one valuable metal.

*Tailings* of a previous process may be used as a feed in another process to extract a secondary product from the original ore.

Additionally, a concentrate may contain more than one valuable metal. That concentrate would then be processed to separate the valuable metals into individual constituents.

## **Hydrometallurgy**

This is concerned with extraction processes involving aqueous solutions used to extract the desired metal or metals from the raw ore.

### **Leaching process**

The first step in the hydrometallurgical process is *leaching*, which involves dissolution of the valuable metals into the aqueous solution and/or a suitable solvent.

### **Purification and concentrating processes**

After the solution is separated from the ore solids, the extract is often subjected to various processes of purification and concentration before the valuable metal is recovered either in its metallic state or as a chemical compound. This may include precipitation, distillation, adsorption, and solvent extraction.

### **Final recovery processes**

The final recovery step may involve precipitation, cementation, or electrometallurgical processing.

## **Pretreatment**

Sometimes, hydrometallurgical processes may be applied directly to the ore material without the need for pretreatment steps. However, often the ore must be pretreated by various mineral processing steps, and sometimes by pyrometallurgical processes.

## **Pyrometallurgy**

This involves high temperature processes where chemical reactions take place among gases, solids, and molten materials.

Solids containing valuable metals are treated to form intermediate compounds for further processing or converted into their elemental or metallic state.

Pyrometallurgical processes that involve gases and solids are typified by calcining and roasting operations.

Processes that produce molten products are collectively referred to as smelting operations.



## **Heat sources used in Pyrometallurgy**

### **Heat via the exothermic chemical reactions**

The energy needed to sustain the high temperatures used in pyrometallurgical processes may be derived from the exothermic nature of the chemical reactions taking place. Typically, these reactions are oxidation, e.g. of sulfide to sulfur dioxide .

### **Heat via electrical arcing or combustion**

Often, energy must be added to the pyrometallurgical process using the combustion of fuel or, in the case of some smelting processes, by the direct application of electrical energy (such as plasma arcing).

## Electrometallurgy

This involves metallurgical processes that take place in some form of electrolytic cell.

*The most common types of electrometallurgical processes are:*

**Electrowinning** - is an electrolysis process used to recover metals in aqueous solution, usually as the result of an ore having undergone one or more hydrometallurgical processes. The metal of interest is plated onto the cathode, while the anode is an inert electrical conductor.

**Electro-refining** - is used to dissolve an impure metallic anode (typically from a smelting process) and produce a high purity cathode.

**Fused salt electrolysis process** - is a process where the valuable metal has been dissolved into a molten salt (which acts as the electrolyte, with the valuable metal collecting on the cathode of the cell. ) The fused salt electrolysis process is conducted at temperatures sufficient to keep both the electrolyte (molten salt) and the metal from being produced in the molten state.

## **Overlapping of electrometallurgy with other processes**

The scope of electrometallurgy significantly overlaps the areas of Hydrometallurgy and (in the case of fused salt electrolysis) Pyrometallurgy.

Additionally, electrochemical phenomena has a considerable role in many mineral processing and hydrometallurgical processes

# Processing of Ores

## **Processing of ores**

The production of metals involves the processing of ores to extract the metal they contain, and the mixture of metals, sometimes with other elements, to produce *alloys*.

## **Processing of ores**

An ore is an occurrence of rock or sediment that contains sufficient minerals with economically important elements, typically metals, that can be economically extracted from the deposit.

The ores are extracted from the earth through mining; they are then refined (often through the process of smelting) to extract the valuable element, or elements.

## Ore grade and ore deposits

The *ore grade*, or concentration of an ore mineral or metal, as well as its form of occurrence, will directly affect the costs associated with mining the ore.

The cost of extraction must thus be weighed against the metal value contained in the rock to determine what ore can be processed and what ore is of too low a grade to be worth mining.

An *ore deposit* is an accumulation of ore. This is distinct from a mineral resource as defined by the mineral resource classification criteria. An ore deposit is one occurrence of a particular ore type.

## Metal ore

Metal ores are generally oxides, sulfides, silicates, or native metals (such as native copper) that are not commonly concentrated in the Earth's crust, or noble metals (not usually forming compounds) such as gold.

The ores must be processed to extract the elements of interest from the waste rock and from the ore minerals.

Ore bodies are formed by a variety of geological processes.

The process of ore formation is called *ore genesis*.



## Oxidation potential of ore

Below are the seven metals mentioned earlier as being used in ancient times. They are arranged in order of their *oxidation potential* (in volts).

- Iron +0.44 V,
- Tin +0.14 V
- Lead +0.13 V
- Copper -0.34 V
- Mercury -0.79 V
- Silver -0.80 V
- Gold -1.50 V

The oxidation potential is important because it is one indication of how tightly bound to the ore the metal is likely to be. (Iron being far more bound to the ore than gold.)

From the list above, it can be seen that iron is significantly higher than the other six metals while gold is much lower than the six above it.

Gold's low oxidation is one of the main reasons that gold is found in nuggets. These nuggets are relatively pure gold and are workable as they are found.

## **Chapter 3: Metal Properties and Alloys**

## **Metal properties**

Metals in general have high electrical conductivity, thermal conductivity, luster and density, and the ability to be deformed under stress without cleaving (separating along the grain lines).

Chemical elements which lack these properties are classified as non-metals.

Some elements, known as metalloids, will behave like a metal and at other times like a non-metal. Some examples of metalloids are as follows: boron, arsenic, and silicon.

## **Ferrous (or black) vs non-ferrous (colored) metallurgy**

Metallurgy is subdivided into two classes: ferrous metallurgy (also known as black metallurgy) and non-ferrous metallurgy (also known as colored metallurgy).

- **Ferrous metallurgy** - involves processes and alloys based on iron
- **Non-ferrous metallurgy** - involves processes and alloys based on other metals

The production of ferrous metals accounts for 95 percent of world metal production.

## **Ferrous and nonferrous metal classes**

*Ferrous metals* are those in the iron class and are magnetic in nature.

These metals consist of iron, steel, and alloys related to them.

*Nonferrous metals* are those that are either void of, or contain trace amounts of, ferrous metals.

These are generally divided into the aluminium, copper, magnesium, lead, and similar groups.



## **Pure metals and alloying elements**

Although pure metals are hardly ever used in the industrial world, it helps to know of their properties, as the alloys used in modern industry are combinations of pure metals.

Some of the pure metals discussed in this course are the base metals in these alloys, especially iron, aluminium, and magnesium.

Other metals discussed are the alloying elements present in small quantities but important in their effect, including chromium, molybdenum, titanium, and manganese.

1 H																	2 He																														
3 Li	4 Be											5 B	6 C	7 N	8 O	9 F	10 Ne																														
11 Na	12 Mg											13 Al	14 Si	15 P	16 S	17 Cl	18 Ar																														
19 K	20 Ca	21 Sc	22 Ti	23 V	24 Cr	25 Mn	26 Fe	27 Co	28 Ni	29 Cu	30 Zn	31 Ga	32 Ge	33 As	34 Se	35 Br	36 Kr																														
37 Rb	38 Sr	39 Y	40 Zr	41 Nb	42 Mo	43 Tc	44 Ru	45 Rh	46 Pd	47 Ag	48 Cd	49 In	50 Sn	51 Sb	52 Te	53 I	54 Xe																														
55 Cs	56 Ba	57-71	72 Hf	73 Ta	74 W	75 Re	76 Os	77 Ir	78 Pt	79 Au	80 Hg	81 Tl	82 Pb	83 Bi	84 Po	85 At	86 Rn																														
87 Fr	88 Ra	89-103	104 Rf	105 Db	106 Sg	107 Bh	108 Hs	109 Mt	110 Ds	111 Rg	112 Cn	113 Nh	114 Fl	115 Mc	116 Lv	117 Ts	118 Og																														
<table border="1"> <tr> <td>57 La</td> <td>58 Ce</td> <td>59 Pr</td> <td>60 Nd</td> <td>61 Pm</td> <td>62 Sm</td> <td>63 Eu</td> <td>64 Gd</td> <td>65 Tb</td> <td>66 Dy</td> <td>67 Ho</td> <td>68 Er</td> <td>69 Tm</td> <td>70 Yb</td> <td>71 Lu</td> </tr> <tr> <td>89 Ac</td> <td>90 Th</td> <td>91 Pa</td> <td>92 U</td> <td>93 Np</td> <td>94 Pu</td> <td>95 Am</td> <td>96 Cm</td> <td>97 Bk</td> <td>98 Cf</td> <td>99 Es</td> <td>100 Fm</td> <td>101 Md</td> <td>102 No</td> <td>103 Lr</td> </tr> </table>																		57 La	58 Ce	59 Pr	60 Nd	61 Pm	62 Sm	63 Eu	64 Gd	65 Tb	66 Dy	67 Ho	68 Er	69 Tm	70 Yb	71 Lu	89 Ac	90 Th	91 Pa	92 U	93 Np	94 Pu	95 Am	96 Cm	97 Bk	98 Cf	99 Es	100 Fm	101 Md	102 No	103 Lr
57 La	58 Ce	59 Pr	60 Nd	61 Pm	62 Sm	63 Eu	64 Gd	65 Tb	66 Dy	67 Ho	68 Er	69 Tm	70 Yb	71 Lu																																	
89 Ac	90 Th	91 Pa	92 U	93 Np	94 Pu	95 Am	96 Cm	97 Bk	98 Cf	99 Es	100 Fm	101 Md	102 No	103 Lr																																	

## Periodic Table

In the table above, the metals are those in the lower left toward the middle, the metalloids are the green-coded elements, and the non-metals are the brown elements in the upper right corner.

## **Alloy metals**

An alloy is a mixture of two or more elements in solid solution in which the main element is a metal. Most pure metals are either too soft, brittle, or chemically reactive for practical use.

Combining different ratios of metals as alloys modifies the properties of the resultant metals to produce desirable characteristics.

The reason for making alloys is generally to create a less brittle, harder, corrosion resistant material, or one with a more desirable color and luster.



## **Iron alloys**

Of the metallic alloys in use today, the alloys of iron (steel, stainless steel, cast iron, tool steel, alloy steel) make up the largest proportion by both quantity and commercial value.

Iron alloyed with various proportions of carbon gives low-, mid- and high-carbon steels, and as the carbon levels increase, ductility and toughness decrease.

The addition of silicon will produce cast irons, while the addition of chromium, nickel, and molybdenum to carbon steels (more than 10%) results in stainless steels.

## Conductive alloys

Aluminium, titanium, copper, and magnesium alloys are also significant in commercial value.

Copper alloys have many applications in the modern world, most importantly in electrical wiring.



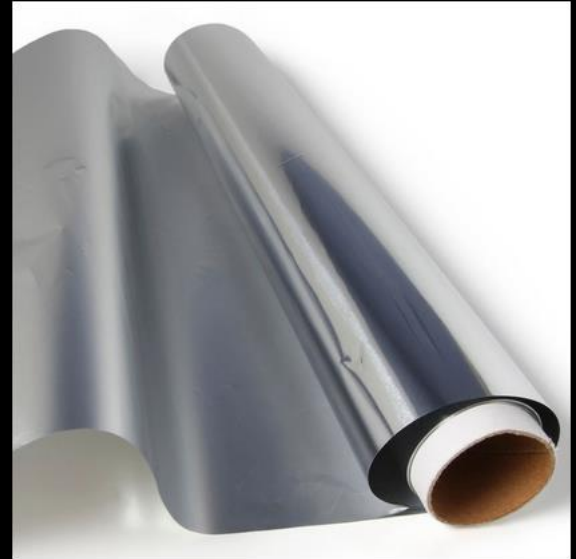

## High strength to weight ratio

The alloys of aluminium, titanium, and magnesium are valued for their high strength-to weight ratios.

These materials are ideal for situations where high strength-to-weight ratio is more important than material cost, such as in aerospace and some automotive applications.

**Table 1-1 Symbols of Base Metals and Alloying Elements.**

<b>Element</b>	<b>Symbol</b>
Aluminum	Al
Antimony	Sb
Cadmium	Cd
Carbon	C
Chromium	Cr
Cobalt	Co
Copper	Cu
Iron	Fe
Lead	Pb
Magnesium	Mg
Manganese	Mn
Molybdenum	Mo
Nickel	Ni
Phosphorus	P
Silicon	Si
Sulfur	S
Tin	Sn
Tungsten	W
Vanadium	V
Zinc	Zn

## **Chemical symbols of metals**

Alloys specially designed for highly demanding applications, such as jet engines, may contain more than ten elements.

## Characteristics of elements

Since we work mostly with alloys, its important to understand their characteristics.

*The characteristics of elements and alloys are explained in terms of physical, chemical, electrical, and mechanical properties:*

- Physical properties relate to color, density, weight, and heat conductivity.
- Chemical properties involve the behaviour of the metal when placed in contact with the atmosphere, salt water, or other substances.
- Electrical properties encompass the electrical conductivity, resistance, and magnetic qualities of the metal.
- Mechanical properties relate to load-carrying ability, wear resistance, hardness, and elasticity.

## **Determining of a metal's properties**

When selecting stock for a job, the main concern is the mechanical properties of the metal.

The various properties of metals and alloys were determined in the manufacturers' laboratories and by various societies interested in metallurgical development.

## **Charts of a metal's properties**

Charts presenting the properties of a particular metal or alloy are available in many commercially published reference books.

The charts provide information on the melting point, tensile strength, electrical conductivity, magnetic properties, and other properties of a particular metal or alloy.

Simple tests can be conducted to determine some of the properties of a metal; however, we normally use a metal test only as an aid for identifying a piece of stock.

Some of these methods of testing are discussed later in this course.

## **Chapter 4: Mechanical Properties of Metals**



## **Types of mechanical properties**

Strength, hardness, toughness, elasticity, plasticity, brittleness, and ductility and malleability are mechanical properties used as measurements of how metals behave under a load.

These properties are described in terms of the types of force or stress that the metal must withstand and how these are resisted.

Common types of stress are compression, tension, shear, torsion, impact, or a combination of these stresses, such as fatigue

## Compressive stress

Compression stresses develop within a material when forces compress or crush the material.

A column that supports an overhead beam is in compression, and the internal stresses that develop within the column are compressive.

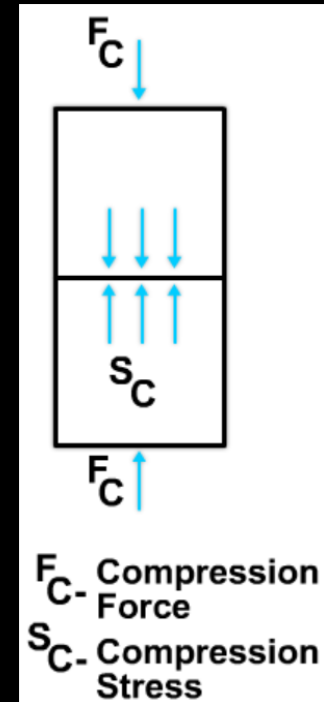

## Tensile stress

Tension (or tensile) stresses develop when a material is subject to a pulling load. For example, when a wire rope is used to lift a load or when using it as a guy to anchor an antenna.

“Tensile strength” is defined as resistance to longitudinal stress or pull, and can be measured in pounds per square inch of cross section.

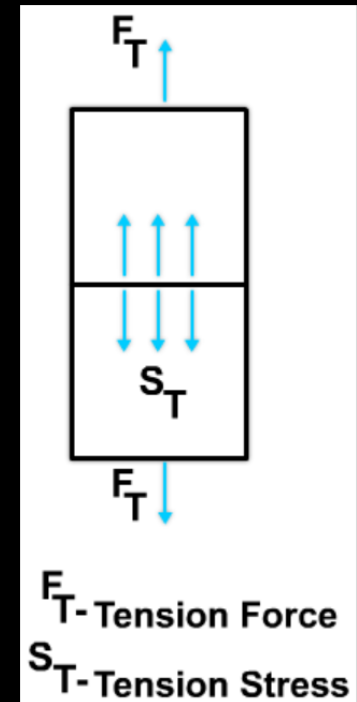

## Shearing stresses

Shearing stresses occur within a material when external forces are applied along parallel lines in opposite directions.

Shearing forces can separate material by sliding part of it in one direction and the rest in the opposite direction.

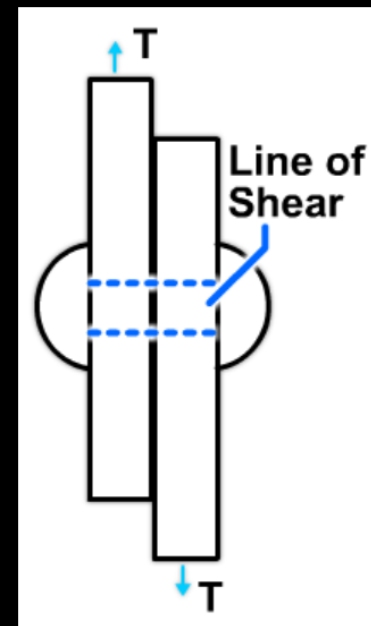

## **Strength variations between force types**

Some materials are equally strong in compression, tension, and shear.

However, many materials show marked differences; for example, cured concrete has a maximum strength of 2,000 psi in compression, but only 400 psi in tension.

Carbon steel has a maximum strength of 56,000 psi in tension and compression but a maximum shear strength of only 42,000 psi; therefore, when dealing with maximum strength, one should always state the type of loading.

## Fatigue

Fatigue is the tendency of a material to fail after repeated bending at the same point.

A repeatedly stressed material usually fails at a point considerably below its maximum strength in tension, compression, or shear.

For example, a thin steel rod can be broken by hand by bending it back and forth several times in the same place; however, if the same force is applied in a steady motion (not bent back and forth), the rod cannot be broken.

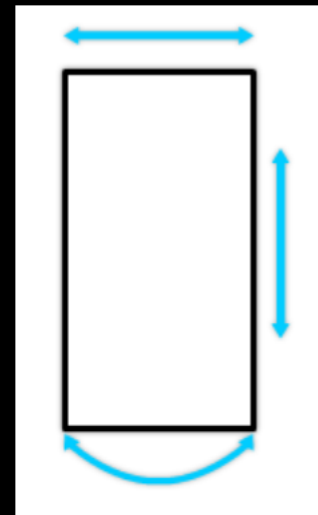

## **Chapter 5: Strength in Metals**

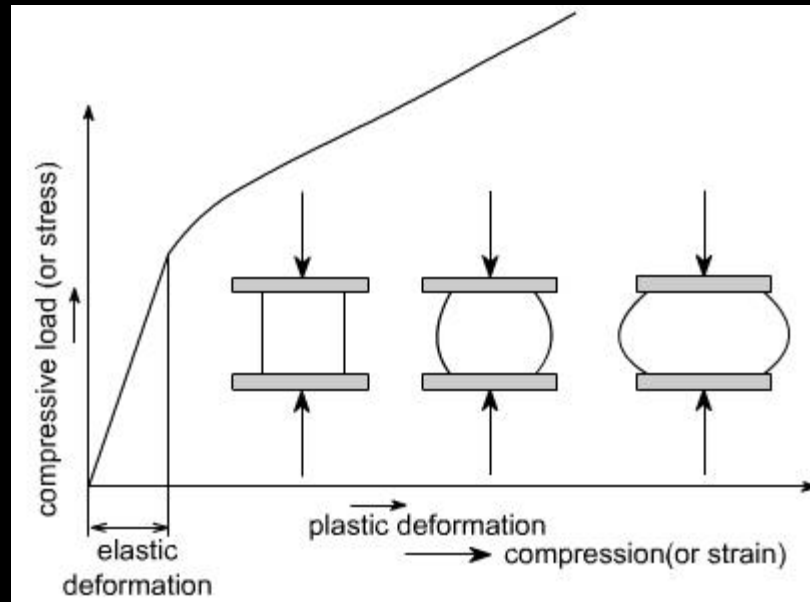

## Compressive strength

Strength is the property that enables a metal to resist deformation under load.

Compressive strength is the maximum load in compression a material will withstand before a predetermined amount of deformation, or the ability of a material to withstand pressures acting in a given plane.

The compressive strength of both cast iron and concrete is greater than their tensile strength. For most materials, the reverse is true.



## **Shear strength**

Shear strength is the ability of a material to resist being fractured by opposing forces acting in a straight line but not in the same plane, or the ability of a metal to resist being fractured by opposing forces not acting in a straight line.

## Tensile strength

Tensile strength is defined as the maximum load in tension a material will withstand before fracturing (image), or the ability of a material to resist being pulled apart by opposing forces.

Also known as ultimate strength, it is the maximum strength developed in a metal in a tension test.

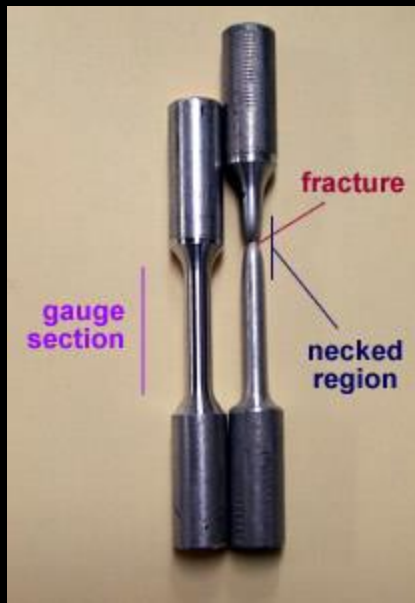

## Tension test

The tension test is a method for determining the behaviour of a metal under an actual stretch loading.

This test provides the elastic limit, elongation, yield point, yield strength, tensile strength, and the reduction in area.



The tensile strength is the value most commonly given for the strength of a material and is given in pounds per square inch (psi) or kilo-Pascals (kPa).

The tensile strength is the number of pounds of force required to pull apart a bar of material 1.0 in. (25.4 mm) wide and 1.00 in. (25.4 mm) thick.

## **Fatigue strength**

Fatigue strength is the maximum load a material can withstand without failure during a large number of reversals of load. For example, a rotating shaft that supports a weight has tensile forces on the top portion of the shaft and compressive forces on the bottom.

As the shaft is rotated, there is a repeated cyclic change in tensile and compressive strength.

Fatigue strength values are used in the design of aircraft wings and other structures subject to rapidly fluctuating loads. Fatigue strength is influenced by microstructure, surface condition, corrosive environment, and cold work.

Impact strength is the ability of a metal to resist suddenly applied loads and is measured in foot-pounds of force.

## **Hardness**

Hardness is defined as resistance of metal to plastic deformation, usually by indentation. However, the term may also refer to stiffness (temper) or to resistance to scratching, abrasion, or cutting.

It is the property of a metal which gives it the ability to resist being permanently deformed (bent, broken, or have its shape changed) when a load is applied.

The greater the hardness of the metal, the greater resistance it has to deformation.

There are several methods of measuring the hardness of a material, so hardness is always specified in terms of the particular test used.

## Hardness testing

*The metals industry uses three types of hardness tests with accuracy:*

- Brinell
- Rockwell
- Vickers

Since the definitions of metallurgic ultimate strength and hardness are rather similar, it can generally be assumed that a strong metal is also a hard metal.

These hardness tests measure a metal's hardness by determining the metal's resistance to the penetration of a non-deformable ball or cone.

The tests determine the depth to which such a ball or cone will sink into the metal under a given load within a specific period of time.

## Rockwell test

Of these three tests, Rockwell is the most frequently used, the basic principle being that a hard material can penetrate a softer one, so you measure the amount of penetration and compare it to a scale.



## Rockwell test (continued)

In regular Rockwell testing the minor load is always 10 kgf (kilograms of force).

The major load can be any of the following loads: 60 kgf, 100 kgf, or 150 kgf. No Rockwell hardness value is specified by a number alone.

It must always be prefixed by a letter signifying the value of the major load and type of penetrator (e.g., HRC 35).

A letter has been assigned for every possible combination of load and penetrator, as given in Table 1-2.

Table 1-2 — Rockwell Hardness Scale.

Scale symbol	Penetrator	Load in Kilograms-Force (Kgf)
A*	Diamond tip*	60
B	1/16" ball	100
C	Diamond tip	150
D	Diamond tip	100
E	1/8" ball	100
F	1/16" ball	60
G	1/16" ball	150
H	1/8" ball	60
K	1/8" ball	150
L	1/4" ball	60
M	1/4" ball	100
P	1/4" ball	150
R	1/2" ball	60
S	1/2" ball	100
V	1/2" ball	150

\* Two scales – carbide and steel.



## Rockwell testers

Each test yields a Rockwell hardness value on your tester. Testers with dial gauges (image) have two sets of figures: red and black.

When the diamond penetrator is used, the readings are taken from the black divisions.

When testing with any of the ball penetrators, the readings are taken from the red divisions.

Testers with digital displays have a scale selection switch, allowing an automatic display of the Rockwell hardness number on its screen.



## Rockwell readings

The regular Rockwell scales are established such that an infinitely hard material will read 100 on the diamond penetrator scales and 130 on the ball penetrator scales.

One regular Rockwell number represents a penetration of 0.002 mm (0.000080 inch).

Therefore, a reading of C60 indicates penetration from a minor to major load of (100 to 60 Rockwell points)  $\times$  0.002 mm = 0.080 mm or 0.0032 inch.

A reading of B80 indicates a penetration of (130 to 80 Rockwell points)  $\times$  0.002 = 0.100 mm or 0.004 inch (image to right).

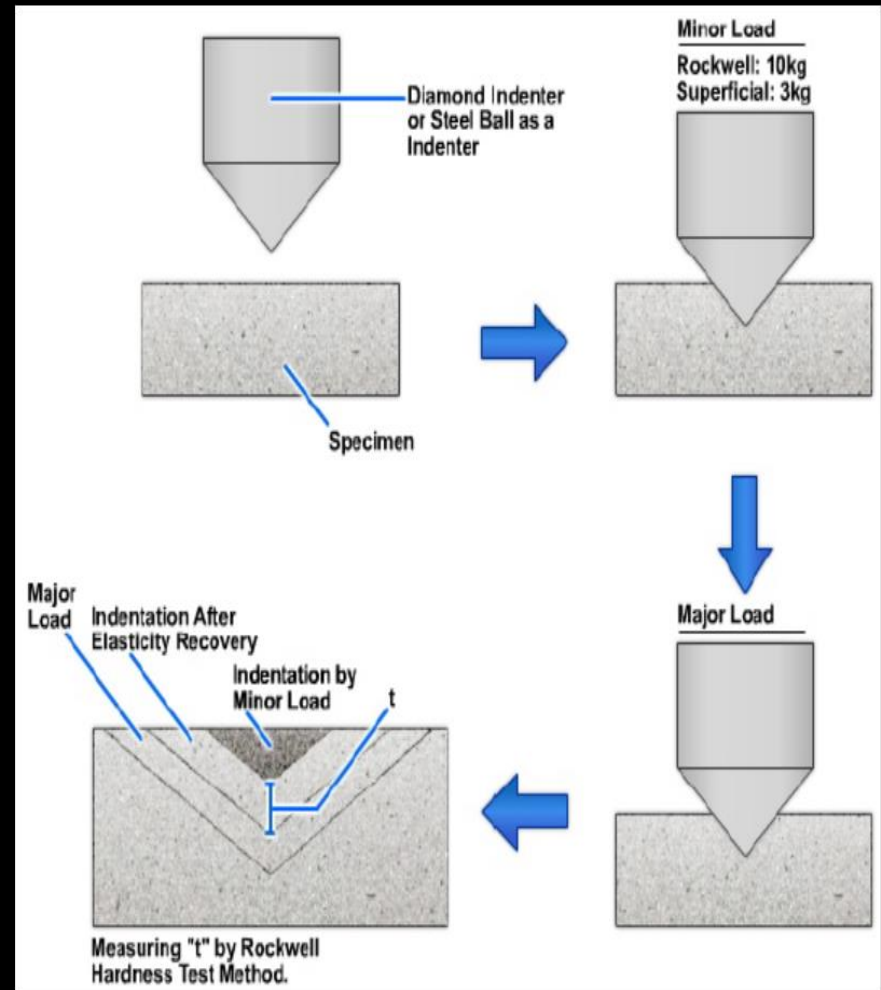

## Toughness

*Toughness* is the property that enables a material to withstand shock and be deformed without rupturing.

Toughness may be considered as a combination of strength and plasticity.

Table 1-3 shows the order of some of the more common materials for toughness as well as other properties.

Table 1-3 — Mechanical Properties of Metals/Alloys.

Toughness	Brittleness	Ductility	Malleability	Corrosion Resistance
Copper	White cast iron	Gold	Gold	Gold
Nickel	Gray cast iron	Silver	Silver	Platinum
Iron	Hardened steel	Platinum	Aluminum	Silver
Magnesium	Bismuth	Iron	Copper	Mercury
Zinc	Manganese	Nickel	Tin	Copper
Aluminum	Bronzes	Copper	Lead	Lead
Lead	Aluminum	Aluminum	Zinc	Tin
Tin	Brass	Tungsten	Iron	Nickel
Cobalt	Structural steels	Zinc		Iron
Bismuth	Zinc	Tin		Zinc
	Monel	Lead		Magnesium
	Tin			Aluminum
	Copper			
	Iron			

Metals/alloys are ranked in descending order of having the property named in the column heading.

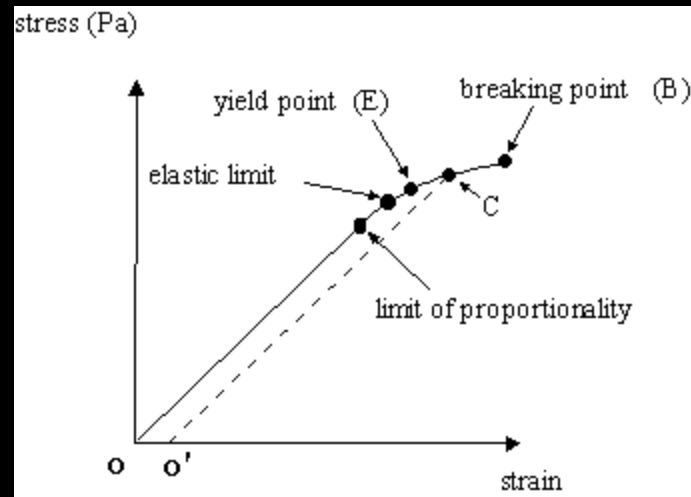

## Elasticity

When a material has a load applied to it, the load causes the material to deform.

*Elasticity* is the ability of a material to return to its original shape after the load is removed.

Theoretically, the elastic limit of a material is the limit to which a material can be loaded and still recover its original shape after the load is removed.

## **Elasticity of metal**

All materials are elastic to some extent. Surprisingly, a piece of steel is more elastic than a rubber band.

The rubber band will stretch more than the steel since it is more easily strained, though the steel returns more closely to its original shape and size and is, therefore, more truly elastic.



## Plasticity

*Plasticity* describes the ability of materials to undergo irreversible deformation without fracture or damage. This property is the opposite of strength.

By careful alloying of metals, the combination of plasticity and strength is used to manufacture large structural members.

For example, should a member of a bridge structure become overloaded, plasticity allows the overloaded member to flow, allowing the distribution of the load to other parts of the bridge structure.

Sheet aluminium (image) has a high plasticity, whereas tool steel has a very low plasticity.

## Brittleness

*Brittleness* is the opposite of plasticity. A brittle metal will break or shatter before it deforms if bent or struck a sharp blow.

Generally, brittle metals are high in compressive strength but low in tensile strength (image shows a brittle type of fracture).

For example, cast iron is very brittle, so you would not use cast iron for fabricating support beams in a bridge.

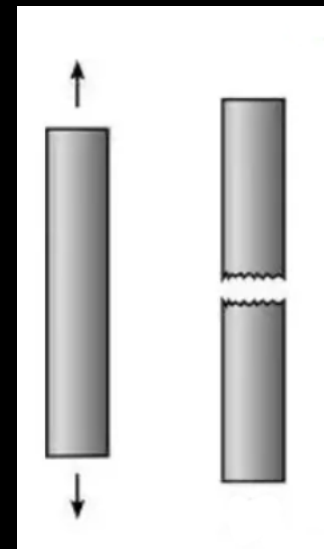

## Ductility and malleability

The properties known as ductility and malleability are special cases of plasticity.

- *Ductility* is the property that makes it possible for a material to withstand extensive permanent deformation from tension. It can be stretched or drawn out into a thin wire. A very ductile metal such as copper or aluminium may be pulled through dies to form wire. (Image shows a ductile fracture, or failure during tension testing).
- *Malleability* is the property that makes it possible for a material to withstand extensive permanent deformation from compression. It can be stamped, hammered, or rolled into thin sheets.

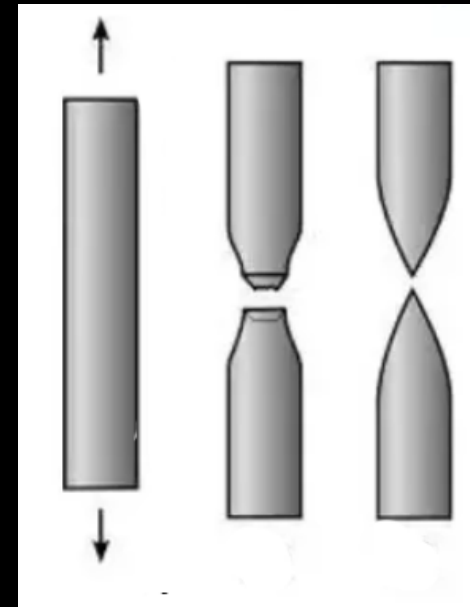



## **Exhibiting of more than one property**

Most metals that exhibit one of these properties also exhibit the other. However, this is not always true.

Lead, for example, is very malleable (it can be permanently deformed in compression without breaking), but it is not ductile (it cannot be permanently deformed in tension to any great extent).

# Chapter 6: Corrosion Resistance

## **Corrosion resistance**

Corrosion resistance is the property that enables a material to resist entering into chemical combination with other substances from attacks by atmospheric, chemical, or electrochemical conditions.

## Corrosion and oxidation

A high degree of corrosion resistance is very desirable in all metals exposed to weather elements.

Most metals are easily corroded, however, as shown by the fact that pure metals occur only rarely in nature.

One of the most common examples of corrosion, sometimes called *oxidation*, is illustrated by the rusting of iron.

## Corrosion in ferrous or non-ferrous metals

Rust (image) occurs as the orange-brown flakes that form on an exposed surface when iron molecules in a ferrous metal reacts with oxygen in the presence of water. This in turn produces iron oxides.



Metals may also react in the presence of acids or harsh industrial chemicals.

If nothing stops the corrosion, flakes of rust will continue to break off, exposing the metal to further corrosion until disintegrate occurs.

Non-ferrous metals can also corrode or tarnish, due to other oxidizing reactions.

## Corrosion resistance

To prevent oxidation and breakdown of metal products, rust-proof or corrosion-proof metals may be used.

*Some basic types of corrosion-proof metals are:*

- Stainless steel
- Aluminum alloy
- Copper
- Bronze
- Brass
- Galvanized steel

Stainless steel, aluminum, copper, bronze and brass are covered later in this course.



## Galvanized steel

Galvanized steel takes a long time to rust, but it will eventually do so with time. Galvanizing consists of a thin layer of zinc (image), applied to the surface of carbon steel.

Zinc acts as a barrier to prevent oxygen and water from reaching the steel, so that it is protected from corrosion.

Even though the zinc coating may become scratched, it will continue to protect localized areas of the underlying steel through cathodic protection, as well as by forming a protective coating of zinc oxide.

Like aluminum, zinc is highly reactive to oxygen in the presence of moisture, and the coating prevents the iron in the steel from further oxidation.

## **Presence of impurities**

The presence of impurities or the presence of alloying elements may greatly alter the corrosion resistance of a metal.

For example, the zinc that is known as “commercially pure” contains a small amount of impurities; this grade of zinc corrodes about 10,000 times as fast as zinc that is chemically pure.



## **Alloying for better corrosion resistance**

On the other hand, many alloys have been developed for the particular purpose of increasing the corrosion resistance of the material.

For example, pure iron would be entirely unsuitable for use in boilers because it has very poor resistance to corrosion, particularly at high temperatures; yet alloys composed primarily of iron are used successfully for this service.

## **Chapter 7: Types of Iron (Ferrous Metals)**

## **Ferrous metals**

Ferrous metals are metals that contain iron. Ferrous metals appear in the form of cast iron, carbon steel, and tool steel.

The various alloys of iron, after undergoing certain processes, are pig iron, gray cast iron, white iron, white cast iron, malleable cast iron, wrought iron, alloy steel, and carbon steel.

All these types of iron are mixtures of iron and carbon, manganese, sulfur, silicon, and phosphorous.

Other elements are also present, but in amounts that do not appreciably affect the characteristics of the metal. Normally, ferrous metals are magnetic and nonferrous metals are nonmagnetic.



## Pure iron

Pure iron rarely exists outside of the laboratory. Iron is produced by reducing iron ore to pig iron by using a blast furnace.

From pig iron, many other types of iron and steel are produced by the addition or deletion of carbon and alloys.

The following, are the different types of iron and steel that can be made from iron ore.

## Pig iron

Pig iron is about 93% iron, from 3% to 5% carbon, with various amounts of other elements.

Pig iron is comparatively weak and brittle; therefore, it has a limited use as is (cast iron pipe and some fittings and valves), and approximately ninety percent of it is refined to produce steel.



## Wrought iron

Wrought iron is almost pure iron. It is made from pig iron in a puddling furnace and has a carbon content of less than 0.08 percent.

Carbon and other elements present in pig iron are taken out, leaving almost pure iron. In the process of manufacture, some slag is mixed with iron to form a fibrous structure in which long stringers of slag, running lengthwise, are mixed with long threads of iron.

Because of the presence of slag, wrought iron resists corrosion and oxidation which cause rusting.



## **Wrought iron (continued)**

The chemical analyses of wrought iron and mild steel are just about the same. The difference comes from the properties controlled during the manufacturing process.

Wrought iron can be gas and arc welded, machined, plated, and easily formed; however, it has a low hardness and a low fatigue strength.

## Cast iron

Cast iron is a manmade alloy of iron, carbon, and silicon. A portion of the carbon exists as free carbon or graphite.

Cast iron is any iron containing greater than 2% carbon alloy, with most cast irons ranging between 2.1% to 4% by weight.

Cast iron has a high compressive strength and good wear resistance; however, it lacks ductility, malleability, and impact strength.



Alloying it with nickel, chromium, molybdenum, silicon, or vanadium improves toughness, tensile strength, and hardness.

A malleable cast iron is produced through a prolonged annealing process.





## Ingot iron

Ingot iron is a commercially pure (99.85% iron), easily formed iron, with good ductility and corrosion resistance. The chemical analysis and properties of ingot iron are practically the same as the lowest carbon steel. The lowest carbon steel, known as dead-soft, has about 0.06% more carbon than ingot iron.

Carbon content in iron is considered an impurity; carbon content in steel is considered an alloying element. The primary use for ingot iron is for galvanized and enamelled sheet.

## **Chapter 8: Types of Steel (Another Ferrous Metal)**



## Steel

Steel is an alloy consisting mostly of iron, with carbon content between 0.2% and 2.1% by weight, depending on the grade.

Steel contains less carbon than cast iron (2.1% to 4%), but considerably more than wrought iron (less than 0.08%).

Basic carbon steels are alloyed with other elements, such as chromium and nickel, to increase certain physical properties of the metal.

Steel can be machined, welded, and forged, all to varying degrees, depending on the type of steel.



## Classifying steel

Steels and other metals are classified based on method of manufacture, method of shaping, method of heat treatment, properties, intended use, and chemical composition. In addition, certain steels and other metals are often referred to by trade names.

Probably the most reasonable way to classify steels is by their chemical composition. Steels that derive their properties primarily from the presence of carbon are referred to merely as “steels” or sometimes as “plain carbon steels.”

Steels that derive their properties primarily from the presence of some alloying element other than carbon are referred to as “alloys” or “alloy steels.”



## Low carbon steel

Low-carbon steel (0.05% to 0.30% carbon) is tough and ductile, and can be rolled, punched, sheared, and worked when either hot or cold.

It is easily machined and can readily be welded by all methods.

It does not respond to heat-treating; however, it can easily be case hardened.



## Medium carbon steel

Medium-carbon steel (0.30% to 0.45% carbon) is strong and hard but cannot be welded or worked as easily as the low-carbon steels.

It may be heat-treated after fabrication.

It is used for general machining and forging of parts that require surface hardness and strength, such as crane hooks, axles, shafts, setscrews, and so on.

Medium-carbon steel is made in bar form in the cold-rolled or the normalized and annealed condition.

During welding, the weld zone will become hardened if cooled rapidly and must be stress-relieved after welding.

## High carbon steel

High-carbon steel (0.45% to 0.75% carbon) and very high-carbon steel (0.75% to 1.70% carbon) respond well to heat treatment and can be welded with difficulty, but the welding must be done using specific processes due to the hardening effect of heat at the welded joint.

This steel is used for the manufacture of drills, taps, dies, springs, and other machine tools and hand tools that are heat-treated after fabrication to develop the hard structure necessary to withstand high shear stress and wear.

It is manufactured in bar, sheet, and wire forms, and in the annealed or normalized condition in order to be suitable for machining before heat treatment.



## Tool steel

Tool steel (0.70% to 1.40% carbon) refers to a special variety of carbon and alloy steels particularly well suited to be made into tools.

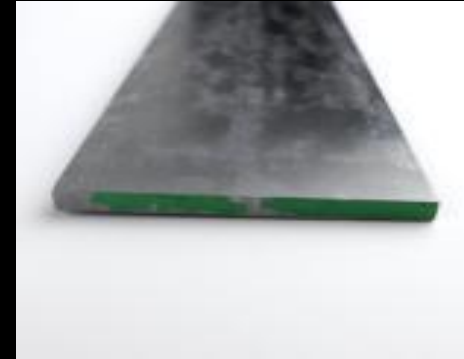

Tool steels are made to a number of grades for different applications.

Choice of grade depends on, among other things, whether a keen cutting edge is necessary, abrasion resistance is paramount, or the tool must withstand impact loading encountered with such tools as axes, pickaxes, and quarrying implements.

Tool steel is used to manufacture chisels, shear blades, cutters, large taps, woodturning tools, blacksmith's tools, razors, and similar parts where high hardness is required to maintain a sharp cutting edge.

It is very difficult to weld due to the high carbon content. A spark test shows a moderately large volume of white sparks having many fine, repeating bursts.



### **Low-alloy, high-strength, tempered structural steel**

This is a special low-carbon steel, containing specific small amounts of alloying elements, that is quenched and tempered to get a yield strength greater than 50,000 psi and tensile strengths of 70,000 to 120,000 psi.

Structural members made from these high-strength steels may have smaller cross-sectional areas than common structural steels and still have equal or greater strength. Additionally, these steels are normally more corrosion and abrasion resistant. High-strength steels are covered by ASTM specifications.

*This type of steel is much tougher than low-carbon steels. Shearing machines for this type of steel must have twice the capacity than that required for low-carbon steels.*



## **Stainless steel**

This type of steel is classified by the American Iron and Steel Institute (AISI) into two general series named the 200-300 series and the 400 series.

Each series includes several types of steel with different characteristics.



## **200-300 series (austenitic steel)**

This type of steel is classified by the American Iron and Steel Institute (AISI) into two general series named the 200-300 series and the 400 series. Each series includes several types of steel with different characteristics.

The 200-300 series of stainless steel is known as austenitic. Austenitic wrought stainless steel is classified in three groups:

- The AISI 200 series (alloys of iron-chromium-nickel-manganese)
- The AISI 300 series (alloys of iron-chromium-nickel)
- Nitrogen-strengthened alloys

Carbon content is usually low (0.15% or less), and the alloys contain a minimum of 16% chromium with sufficient nickel and manganese to provide an austenitic structure at all temperatures from the cryogenic region to the melting point of the alloy.

## **Nitrogen strengthening of austenitic steel**

Nitrogen-strengthened austenitic stainless steels are alloys of chromium-manganese nitrogen; some grades also contain nickel.

Yield strengths of these alloys (annealed) are typically 50% higher than those of the non-nitrogen-bearing grades. They are nonmagnetic, and most remain so, even after severe cold working

Like carbon, nitrogen increases the strength of a steel, but unlike carbon, nitrogen does not combine significantly with chromium in a stainless steel. This combination, which forms chromium carbide, reduces the strength and corrosion resistance of an alloy.

Until recently, metallurgists had difficulty adding controlled amounts of nitrogen to an alloy. The development of the argon-oxygen decarburization (AOD) method has made possible strength levels formerly unattainable in conventional annealed stainless alloys.

## **Corrosion resistant applications**

Austenitic stainless steels are generally used where corrosion resistance and toughness are primary requirements. Typical applications include shafts, pumps, fasteners, and piping in seawater, and equipment for processing chemicals, food, and dairy products.

The most well known types of steel in this series are the 302 and 304. They are commonly called 18-8 because they are composed of 18% chromium and 8% nickel. The chromium nickel steels are the most widely used and are normally nonmagnetic.

## **400 series of steel**

The 400 series of steel is subdivided according to their crystalline structure into two general groups.

One group is known as ferritic chromium and the other group as martensitic chromium.

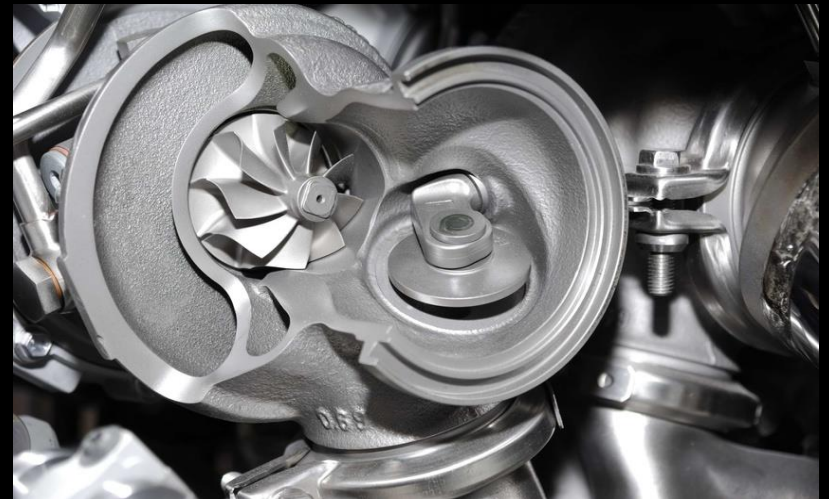

## Ferritic chromium steel

Ferritic chromium contains 10.5% to 27% chromium and 0.08% to 0.20% carbon. Low in carbon content but generally higher in chromium than the martensitic grades, these steels cannot be hardened by heat treating and are only moderately hardened by cold working.

Ferritic stainless steels (image) are the straight chromium grades of stainless steel since they contain no nickel; they are magnetic and retain their basic microstructure up to the melting point if sufficient Cr and Mo are present.

In the annealed condition, strength of these grades is approximately 50% higher than that of carbon steels.

## **Ferritic chromium steel (continued)**

Ferritic stainless steels are typically used where moderate corrosion resistance is required and where toughness is not a major need.

They are also used where chloride stress-corrosion cracking may be a problem because they have high resistance to this type of corrosion failure.

In heavy sections, achieving sufficient toughness is difficult with the higher-alloyed ferritic grades.

Typical applications include automotive trim and exhaust systems and heat-transfer equipment for the chemical and petrochemical industries



## Martensitic chromium steel

Martensitic chromium contains from 11.5 to 18% chromium, 0.15% to 1.2% carbon, and up to 2.5% nickel.

They are magnetic, can be hardened by heat treatment, and have high strength and moderate toughness in the hardened-and-tempered condition. Forming should be done in the annealed condition.

Martensitic stainless steels are less resistant to corrosion than the austenitic or ferritic grades.

Two types of martensitic steels, 416 and 420F, have been developed specifically for good machinability.

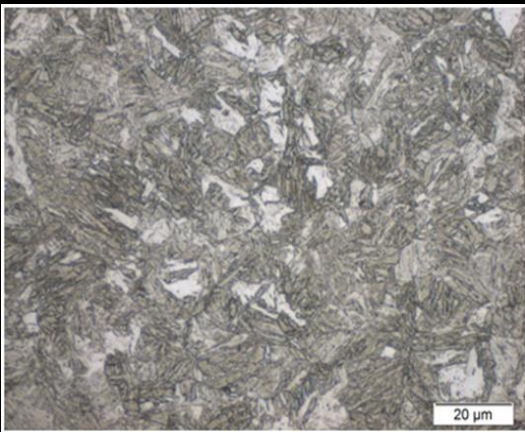

### **Martensitic chromium steel (continued)**

Martensitic stainless steels are used where strength and/or hardness are of primary concern and where the environment is relatively mild from a corrosive standpoint.

These alloys are typically used for bearings, molds, cutlery, medical instruments, aircraft structural parts, and turbine components.

Type 420 is used increasingly for molds for plastics and for industrial components requiring hardness and corrosion resistance.

## **Alloy steels**

Steels that derive their properties primarily from the presence of some alloying element other than carbon are called alloys or alloy steels.

Alloy steels always contain traces of other elements.

Among the more common alloying elements are nickel, chromium, vanadium, silicon, and tungsten.

One or more of these elements may be added to the steel during the manufacturing process to produce the desired characteristics.

### **Alloy steels (continued)**

Alloy steels may be produced in structural sections, sheets, plates, and bars for use in the “as-rolled” condition.

Better physical properties are obtained with these steels than are possible with hot-rolled carbon steels.

These alloys are used in structures where the strength of material is especially important, such as bridge members, railroad cars, dump bodies, dozer blades, and crane booms.



## Nickel steels

These alloy steels contain from 3.5% nickel to 5% nickel. The nickel increases the strength and toughness of these steels.

Nickel steel containing more than 5% nickel has an increased resistance to corrosion and scale.

Nickel steel is used in the manufacture of aircraft parts, such as propellers and airframe support members.



## Chromium steels

These alloy steels have chromium added to improve hardening ability, wear resistance, and strength.

They contain between 0.20% to 0.75% chromium and 0.45% carbon or more.

Some of these steels are so highly resistant to wear that they are used for the races and balls in anti-friction bearings.

Chromium steels are highly resistant to corrosion and scale.

## Chrome vanadium steel

This alloy steel has the maximum amount of strength with the least amount of weight.

Steels of this type contain from 0.15% to 0.25% vanadium, 0.6% to 1.5% chromium, and 0.1% to 0.6% carbon.

Common uses are for crankshafts, gears, axles, and other items that require high strength.

This steel is also used to manufacture high quality hand tools, such as wrenches and sockets (image).





## **Tungsten steel**

This is a special alloy that has the property of red hardness, that is, the ability to continue to cut after it becomes red-hot.

A good grade of this steel contains from 13% to 19% tungsten, 1% to 2% vanadium, 3% to 5% chromium, and 0.6% to 0.8% carbon.

Because this alloy is expensive to produce, its use is largely restricted to the manufacture of drills, lathe tools, milling cutters, and similar cutting tools.





## **Molybdenum**

This is often used as an alloying agent for steel in combination with chromium and nickel.

The molybdenum adds toughness to the steel.

It can be used in place of tungsten to make the cheaper grades of high-speed steel and in carbon molybdenum high-pressure tubing.



## Manganese steels

The amount of manganese used depends upon the properties desired in the finished product. Small amounts of manganese produce strong, free-machining steels.

Larger amounts (between 2% and 10%) produce a somewhat brittle steel, while still larger amounts (11% to 14%) produce a steel that is tough and very resistant to wear after proper heat treatment.

## **Chapter 9: Nonferrous Metals and Alloys**

## **Nonferrous metals**

Nonferrous metals contain either no iron or only trace amounts used as an alloy.

Some of the more commonly used nonferrous metals include copper, brass, bronze, copper-nickel alloys, lead, zinc, tin, aluminium, and Duralumin.

All nonferrous metals are nonmagnetic.



## Copper

Copper and its alloys have many desirable properties. Copper is ductile, malleable, hard, tough, strong, wear resistant, machinable, weldable, and corrosion resistant.

It also has high-tensile strength, fatigue strength, and thermal and electrical conductivity.

Copper is one of the easier metals to work with, but care must be taken as it can easily become work-hardened.

## Heat treating of copper

Work hardened copper can be remedied by annealing, that is, heating it to a cherry red, and then letting it cool; this process restores it to a softened condition.

Annealing and softening are the only heat-treating procedures that apply to copper.

Seams in copper are joined by riveting, silver brazing, bronze brazing, soft soldering, gas welding, or electrical arc welding.

Copper is frequently used to give a protective coating to sheets and rods and to make ball floats, containers, and soldering coppers.





## Brass

Brass is an alloy of copper and zinc, with additional elements such as aluminium, lead, tin, iron, manganese, or phosphorus added to give the alloy specific properties.

Naval rolled brass (Tobin bronze) contains about 60% copper, 39% zinc, and 0.75% tin. This brass is highly corrosion resistant and is practically impurity free.

## **Grades of brass**

Brass sheets and strips are available in several grades: soft, 1/4 hard, 1/2 hard, full hard, and spring grades.

The process of cold rolling creates hardness.

All grades of brass can be softened by annealing at a temperature of 550°F to 600°F, then allowing it to cool by itself without quenching, but be careful not to overheat; overheating can destroy the zinc in the alloy.





## Bronze

Bronze is a combination of 84% copper and 16% tin, and was the best metal available before steel-making techniques were developed.

Many complex bronze alloys are now available, containing such elements as zinc, lead, iron, aluminium, silicon, and phosphorus, so today, the name bronze is applied to any copper-based alloy that looks like bronze.

In many cases, there is no real distinction between the composition of bronze and that of brass.



## Nickel

Nickel is used in these alloys to make them strong, tough, and resistant to wear and corrosion.

Because of their high resistance to corrosion, copper-nickel alloys, containing 70% copper and 30% nickel or 90% copper and 10% nickel, are used for saltwater piping systems.

Small storage tanks and hot water reservoirs are constructed of a copper-nickel alloy available in sheet form.

Copper-nickel alloys should be joined by metal-arc welding or by brazing.

## Lead

Lead is a heavy metal that weighs about 710 pounds per cubic foot. In spite of its weight, lead is soft, malleable, and available in pig and sheet form (in rolls).



Lead's surface is greyish, but after scratching or scraping it, you can see that the actual color of the metal is white. Because it is soft, lead is used as backing material when punching holes with a hollow punch or when forming shapes by hammering copper sheets.

Sheet lead is also used to line sinks or protect bench tops where a large amount of acid is used. Lead-lined pipes are used in systems that carry corrosive chemicals.

Frequently, lead is used in alloyed form to increase its low-tensile strength. Alloyed with tin, lead produces a soft solder; when added to metal alloys, lead improves their machinability.

When working with lead, you must take proper precautions because the dust, fumes, or vapours from it are highly poisonous.



## Zinc

You often see zinc used on iron or steel in the form of a protective coating called galvanizing.

Zinc is also used in soldering fluxes and die-castings, and as an alloy in making brass and bronze.



## Tin

Tin has many important uses as an alloy. It can be alloyed with lead to produce softer solders and with copper to produce bronze.

Tin-based alloys have a high resistance to corrosion, low-fatigue strength, and a compressive strength that accommodates light or medium loads.

Tin, like lead, has a good resistance to corrosion and has the added advantage of not being poisonous; however, it has a tendency to decompose when subjected to extremely low temperatures.

## Aluminum

Aluminium is easy to work with and has a good appearance. It is light in weight with a high strength per unit weight.

A disadvantage is that its tensile strength is only one third of iron's and one fifth of annealed mild steel's.



Aluminium alloys usually contain at least 90% aluminium, while the addition of silicon, magnesium, copper, nickel, or manganese can raise the strength of the alloy to that of mild steel. In its pure state, aluminium is soft, with a strong affinity for gases.

Alloying elements are used to overcome these disadvantages, but the alloys, unlike the pure aluminium, corrode unless given a protective coating.

Threaded parts made of aluminium alloy should be coated with an anti-seize compound to prevent sticking caused by corrosion.

## Duralumin (2017-T4)

Developed in 1903, Duralumin is one of the first of the strong structural aluminium alloys; it was used in zeppelins, including the Hindenburg.

Over the past hundred years, with the development of a variety of different wrought-aluminium alloys, a numbering system was adopted, with digits indicating the major alloying element and the coldworked or heat-treated condition of the metal.

Today, the name Duralumin is rarely used, and it is now classified in the metal working industries as 2017-T4; the T4 indicates heat treated.





## Alclad

This is a protective covering consisting of a thin sheet of pure aluminium rolled onto the surface of an aluminium alloy during manufacture.

Zinc chromate is a protective covering that can be applied to an aluminium surface as needed, or used as a primer on steel surfaces for a protective coating.

The first aircraft to be constructed from Alclad was the all-metal US Navy airship ZMC-2 (image), constructed in 1927 at by the US Navy. Alclad is a trademark of Alcoa but the term is also used generically.



## Monel

Monel is an alloy in which nickel is the major element. It contains from 64% to 68% nickel, about 30% copper, and small percentages of iron, manganese, and cobalt.

Monel is harder and stronger than either nickel or copper, and has high ductility. It resembles stainless steel in appearance and has many of its qualities.

The strength combined with a high resistance to corrosion makes Monel an acceptable substitute for steel in systems where corrosion resistance is the primary concern. Nuts, bolts, screws, and various fittings are made of Monel.

This alloy can be forged, welded, and worked cold. If worked in the temperature range between 1200°F and 1600°F, it becomes “hot short” or brittle.

*The image shows ID tags made from Monel.*

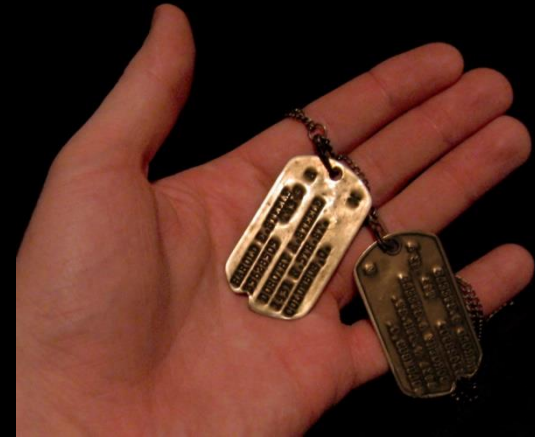

## **K-monel**

K-monel is a special type of alloy developed for greater strength and hardness than Monel.

In strength, it is comparable to heat-treated steel, and is used for instrument parts that must resist corrosion.

## Inconel

Inconel is a family of austenitic nickel-chromium-based superalloys.

Inconel alloys are oxidation-corrosion-resistant materials well suited for service in extreme environments subjected to pressure and heat. When heated, Inconel forms a thick, stable, passivating oxide layer protecting the surface from further attack.

It retains strength over a wide temperature range, attractive for high temperature applications where aluminum and steel would succumb to creep as a result of thermally induced crystal vacancies.

Inconel's high temperature strength is developed by solid solution strengthening or precipitation hardening, depending on the alloy. Inconel is composed of 78.5% nickel, 14% chromium, 6.5% iron, and 1% of other elements.

*The image shows a gate valve made from Inconel.*



# Chapter 10: Metalworking Processes

## **Metalworking**

The act of metalworking spans cultures, civilizations, and millennia throughout history.

Metalworking has evolved from the discovery of smelting various ores, producing malleable and ductile metal useful tools and adornments.

Modern metalworking processes, though diverse and specialized, can be primarily categorized as forming, cutting, or joining processes.

## Cutting and shaping metal

*There are numerous technologies employed to cut and shape metal:*

- Manual technologies: saw, chisel, shear or snips
- Machine technologies: turning, milling, drilling, grinding, sawing
- Welding/burning technologies: burning by laser, oxy-fuel burning, and plasma
- Eroding technologies: by water jet, electric discharge, or abrasive flow machining
- Chemical technologies: Photochemical machining

## Machining

The three principal machining processes are classified as turning, drilling and milling. Other processes include shaping, planing, boring, broaching and sawing.

**Turning** - operations that rotate the workpiece as the primary method of moving metal against the cutting tool. Lathes are the principal machine tool used in turning.

**Milling** - operations in which the cutting tool rotates to bring cutting edges to bear against the workpiece. Vertical milling machines are the principal machine tool used in milling.

**Drilling** - operations in which holes are produced or refined by bringing a rotating cutter with cutting edges at the lower extremity into contact with the workpiece. Drilling operations are done primarily in drill presses but sometimes on lathes or mills.



## Bulk forming

Bulk forming is done through *plastic deformation* (which involves using heat or pressure to make a workpiece more conductive to mechanical force.)

Historically, this and casting were done by blacksmiths, though today the process has been industrialized.

*Examples include:*

- Cold sizing
- Extrusion
- Drawing
- Forging
- Powder metallurgy
- Friction drilling
- Rolling
- Burnishing







## Metal joining

**Welding** is a fabrication process that joins materials, usually metals or thermoplastics, by causing *coalescence*. It often entails melting the workpieces and adding a filler material to form a pool of molten material that cools to become a strong joint.

**Brazing** is a joining process in which a filler metal is melted and drawn into a capillary formed by the assembly of two or more work pieces. The filler metal reacts with the workpiece and solidifies in the capillary, forming a strong joint. Brazing occurs at temperatures in excess of 842 °F. Brazing produces less thermal stress than welding, with assemblies being more ductile than weldment.

**Soldering** occurs at temperatures below 450 °C. Because of the lower joining temperature and different alloys used as fillers, the metallurgical reaction between filler and work piece is minimal, resulting in a weaker joint than that of brazing.

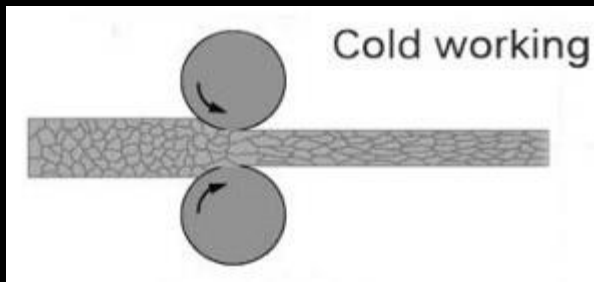

## Cold-working

Cold-working processes, in which the product's shape is altered by rolling, fabrication or other processes while the product is cold, can increase the strength of the product by a process called work hardening.

Work hardening creates microscopic defects in the metal, which resist further changes of shape.

## Work hardening

Work hardening, also known as strain hardening, is the strengthening of a metal or polymer by plastic deformation.



This strengthening occurs because of dislocation movements and dislocation generation within the crystal structure of the material.

Many non-brittle metals with a reasonably high melting point as well as several polymers can be strengthened in this fashion.

Alloys not amenable to heat treatment, including low-carbon steel, are often work-hardened.

Some materials cannot be work-hardened at low temperatures, such as indium, however others can only be strengthened via work hardening, such as pure copper and aluminum.

## Casting

Casting is a process in which a liquid metal is poured into a mold (it is usually delivered by a crucible) that contains a hollow cavity of the intended shape.

The metal is poured into the mold through a hollow channel called a *sprue*.

The metal and mold are then cooled, and the metal part (the casting) is then extracted.

Casting is most often used for making complex shapes that would be difficult or too costly to make by other methods.

Various forms of casting exist in industry and academia. These include sand casting, investment casting (also called the lost wax process), die casting, and continuous castings.

Each of these forms has advantages for certain metals and applications considering factors like magnetism and corrosion.



## Forging

Forging is one of the oldest known metalworking processes.

Traditionally, forging was performed by a smith using hammer and anvil, though introducing water power to the production and working of iron in the 12th century allowed the use of large trip hammers or power hammers that exponentially increased the amount and size of iron that could be produced and forged easily.

The smithy or forge has evolved over centuries to become a facility with engineered processes, production equipment, tooling, raw materials and products to meet the demands of modern industry.

In modern times, industrial forging is done either with presses or with hammers powered by compressed air, electricity, hydraulics or steam. These hammers may have reciprocating weights in the thousands of pounds.

Smaller power hammers, 500 lb or less reciprocating weight, and hydraulic presses are common in art smithies as well.

Some steam hammers remain in use, but they became obsolete with the availability of the other, more convenient, power sources.

## Rolling

Rolling is a metal forming process in which metal stock is passed through one or more pairs of rolls to reduce the thickness and to make the thickness uniform. The concept is similar to the rolling of dough.

Rolling is classified according to the temperature of the metal rolled.

If the temperature of the metal is above its recrystallization temperature, then the process is known as *hot rolling*.

If the temperature of the metal is below its recrystallization temperature, the process is known as *cold rolling*.

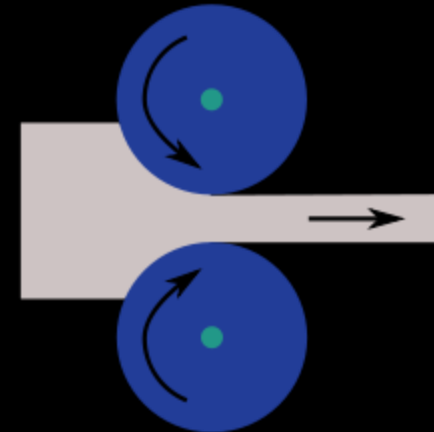

## **Cladding**

Cladding is the bonding together of dissimilar metals. It is different from fusion welding or gluing as a method to fasten the metals together.

Cladding is often achieved by extruding two metals through a die as well as pressing or rolling sheets together under high pressure.

The US Mint uses cladding to manufacture coins from different metals allowing a cheaper metal to be used as a filler.

## Drawing and extrusion

Extrusion is a process used to create objects of a fixed cross-sectional profile. A material is pushed through a die of the desired cross-section.

The two main advantages of this process over other manufacturing processes are its ability to create very complex cross-sections, and to work materials that are brittle, because the material only encounters compressive and shear stresses. It also forms parts with an excellent surface finish.

Drawing is a similar process, which uses the tensile strength of the material to pull it through the die.

This limits the amount of change which can be performed in one step, so it is limited to simpler shapes, and multiple stages are usually needed.

Drawing is the main way to produce wire. Metal bars and tubes are also often drawn.



## Sintering

Sintering is the process of compacting and forming a solid mass of material by heat or pressure without melting it to the point of liquefaction.

Because the sintering temperature does not have to reach the melting point of the material, sintering is often chosen as the shaping process for materials with extremely high melting points such as tungsten and molybdenum.

The study of sintering in metallurgy powder-related processes is known as *powder metallurgy*.

# **Chapter 11: Metal Identification And Testing Methods**

## **Metal identification**

Many methods are used to identify a piece of metal. Identification is necessary when selecting a metal for use in fabrication or in determining its weldability.

Some common methods used for field identification are surface appearance, spark test, chip test, and use of a magnet.

## **Surface appearance**

It is possible to identify several metals by their surface appearance.

Although examination of the surface does not usually give you enough information to classify the metal exactly, it will often give you enough information to allow you to identify the group to which the metal belongs.

Even this much identification is helpful since it will limit the number of tests required for further identification.

In trying to identify a piece of metal by its surface appearance, consider both the color and the texture of the surface.

**Table 1-4 — Surface Colors of Some Common Metals.**

<b>Metals</b>	<b>Color of unfinished, unbroken surface</b>	<b>Color and structure of newly fractured surface</b>	<b>Color of freshly filed surface</b>
<b>White cast iron</b>	Dull gray	Silver white; crystalline	Silvery white
<b>Gray cast iron</b>	Dull gray	Dark gray; crystalline	Light silvery gray
<b>Malleable iron</b>	Dull gray	Dark gray; finely crystalline	Light silvery gray
<b>Wrought iron</b>	Light gray	Bright gray	Light silvery gray
<b>Low-carbon and cast steel</b>	Dark gray	Light gray	Bright silvery gray
<b>Stainless steel</b>	Dark gray	Medium gray	Bright silvery gray
<b>Copper</b>	Reddish brown to green	Bright red	Bright copper color
<b>Brass and bronze</b>	Reddish yellow, yellow-green, of brown	Red to yellow	Reddish yellow to yellowish white
<b>Aluminum</b>	Light gray	White; finely crystalline	White
<b>Monel metal</b>	Dark gray	Light gray	Light gray
<b>Nickel</b>	Dark gray	Off-white	Bright silvery white
<b>Lead</b>	White to gray	Light gray; crystalline	White

## Surface colors

The table above, indicates the surface colors of some of the more common metals.

## Classifying metals based on appearance

Referring to the table, you can see that the outside appearance of a metal helps to identify and classify metal, while newly fractured or freshly filed surfaces offer additional clues.

- Cast iron and malleable iron usually show evidence of the sand mold
- Low-carbon steel often shows forging marks
- High-carbon steel shows either forging or rolling marks. Feeling the surface may provide another clue
- Stainless steel is slightly rough in the unfinished state
- The surfaces of wrought iron, copper, brass, bronze, nickel, and Monel are smooth
- Lead is smooth but has a velvety appearance

## **Other ID methods**

When the surface appearance of a metal does not give enough information to positively identify it, other identification tests become necessary.

Some of these tests are complicated and require equipment often not available; however, some tests are fairly simple and reliable when done by a skilled person.

Three of these tests are the spark test, chip test, and magnetic test.

## The Spark test

Spark testing is a method of determining the general classification of ferrous materials. It normally entails taking a piece of metal, usually scrap, and applying it to a grinding wheel in order to observe the sparks emitted.

These sparks can be compared to a chart or to sparks from a known test sample to determine the classification. Spark testing also can be used to sort ferrous materials, establishing the difference from one another by noting whether the spark is the same or different.

This test does not replace chemical analysis, but it is a very convenient and fast method of sorting mixed steels whose spark characteristics are known.

Spark testing is used because it is quick, easy, and inexpensive. Moreover, test samples do not have to be prepared in any way, so, often, a piece of scrap is used.

The main disadvantage to spark testing is its inability to identify a material positively; if positive identification is required, chemical analysis must be used.

The spark comparison method also damages the material being tested, at least slightly. Spark testing most often is used in tool rooms, machine shops, heat treating shops, and foundries.



## **The test area**

The test area should be in an area where there is no bright light shining directly into the observer's eyes. Moreover, the grinding wheel and surrounding area should be dark so that the sparks can be observed clearly, since the color of the spark is important.

In all cases, it is best to use standard known metal samples to compare their sparks with that of the unknown test sample.

## The test sample

The test sample is then touched lightly to the grinding wheel to produce the sparks.

The important spark characteristics are color, volume, nature of the spark, and length.

Note that the length is dependent on the amount of pressure applied to the grinding wheel, so this can be a poor comparison tool if the pressure is not exactly the same for the samples. Also, the grinding wheel must be dressed frequently to remove metallic build-up.

## **Grinding wheel**

When held lightly against a grinding wheel, the different kinds of iron and steel produce sparks that vary in length, shape, and color.

The grinding wheel should be run to give a surface speed of at least 5000 ft (1525 m) per minute to get a good spark stream.

Grinding wheels should be hard enough to wear for a reasonable length of time, yet soft enough to keep a free-cutting edge.

## **Compressed air method**

Another less common method for creating sparks is heating up the sample to red heat and then applying compressed air to the sample.

The compressed air supplies enough oxygen to ignite the sample and give off sparks. This method is more accurate than using a grinder because it will always give off sparks of the same length for the same sample.

The compressed air applies in essence the same "pressure" each time. This makes observations of the spark length a much more reliable characteristic for comparison.

## **Automated spark testing**

Automated spark testing has been developed to remove the reliance upon operator skill and experience, thereby increasing reliability.

The system relies upon spectroscopy, spectrometry, and other methods to "observe" the spark pattern.

It has been found that this system can determine the difference between two materials that give off sparks that are indistinguishable to the human eye.

## **Spark testing and nonferrous metals**

Spark testing is not of much use on nonferrous metals such as coppers, aluminium, and nickel-base alloys since they do not exhibit spark streams of any significance.

However, this is one way to separate ferrous and nonferrous metals.

The spark resulting from the test should be directed downward and studied.

The color, shape, length, and activity of the sparks relate to characteristics of the material being tested.

The spark stream has specific characteristics which can be identified.

## Carrier lines

The straight lines are called *carrier lines*.

They are usually solid and continuous.

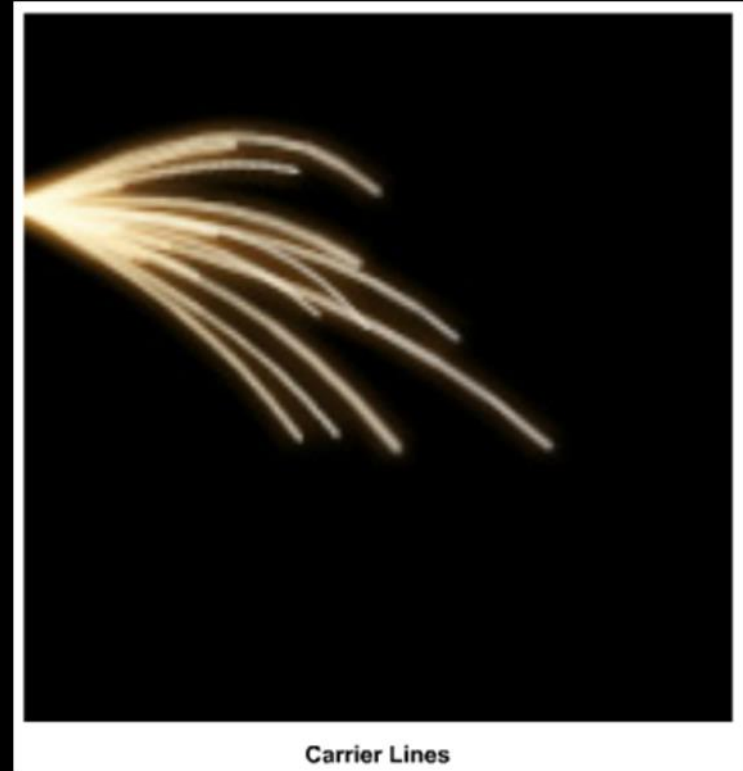

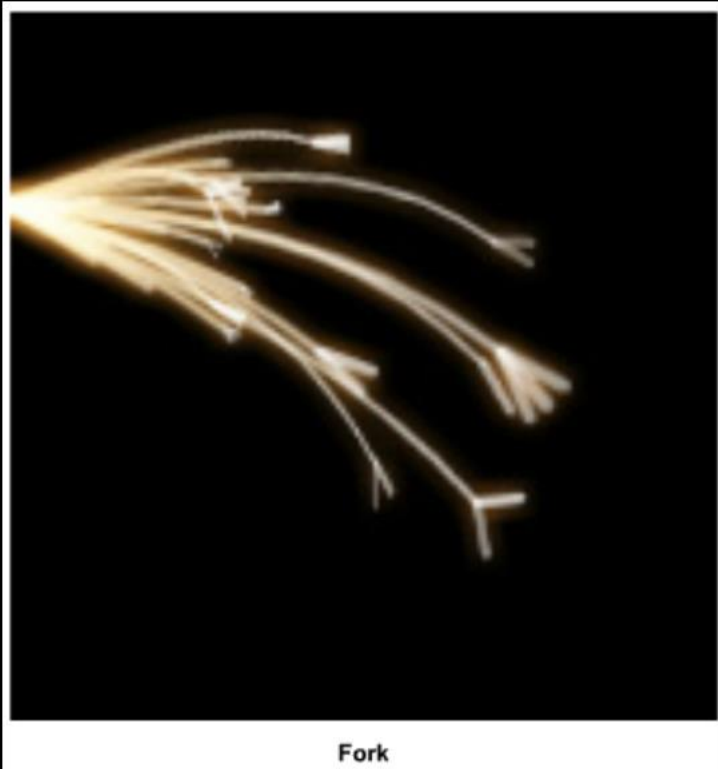

## Forks

At the end of the carrier line, the spark stream may divide into three short lines, or *forks*.





## **Sprigs**

If the spark stream divides into more lines at the end, it is called a sprig.

## **Starbursts or fan bursts**

Sprigs also occur at different places along the carrier line.

These are called either star or fan bursts.

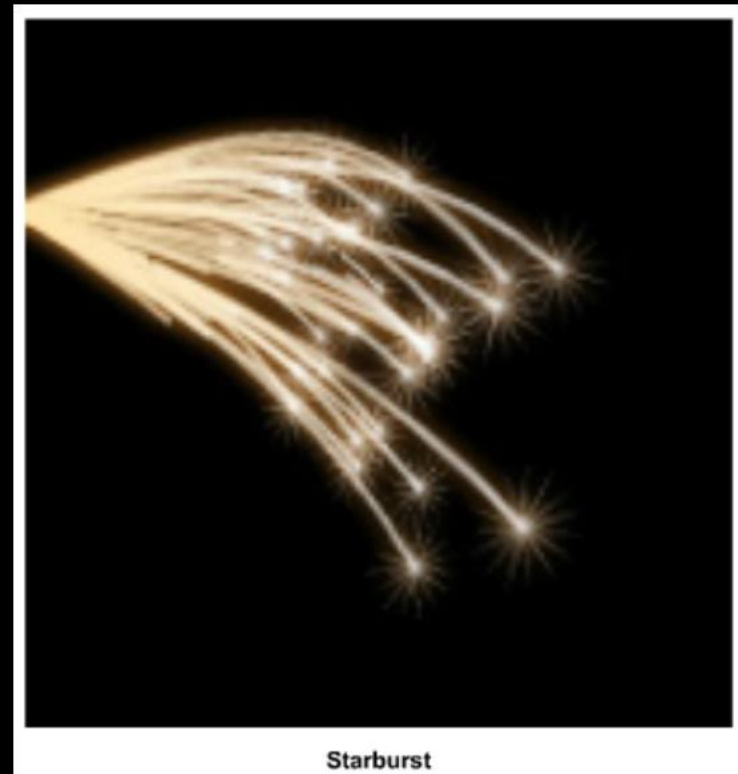

## **Spearpoints or buds**

In some cases, the carrier line will enlarge slightly for a very short length, continue, and perhaps enlarge again for a short length.

When these heavier portions occur at the end of the carrier line, they are called spear points or buds.

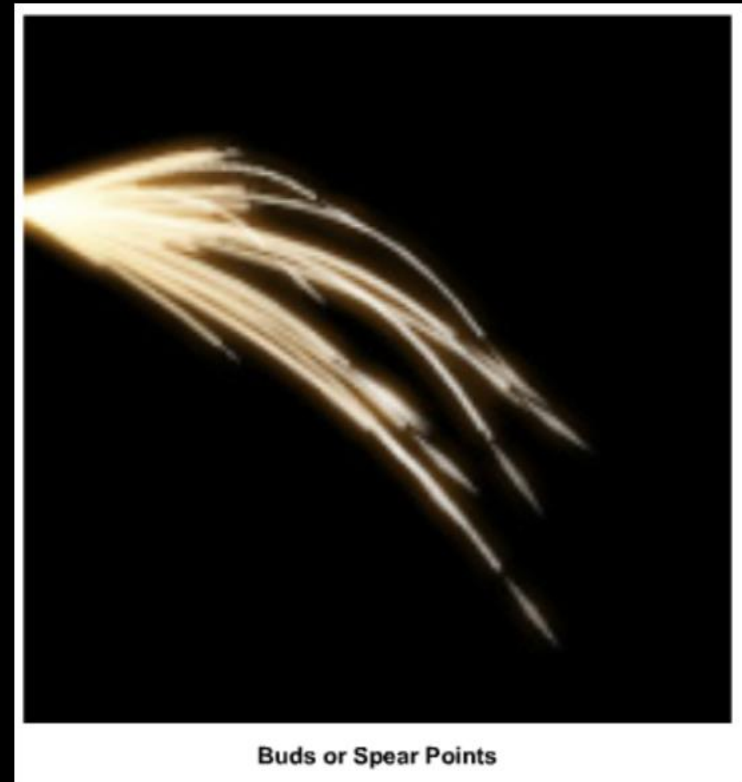

## Dashes

Dashes look like so.....

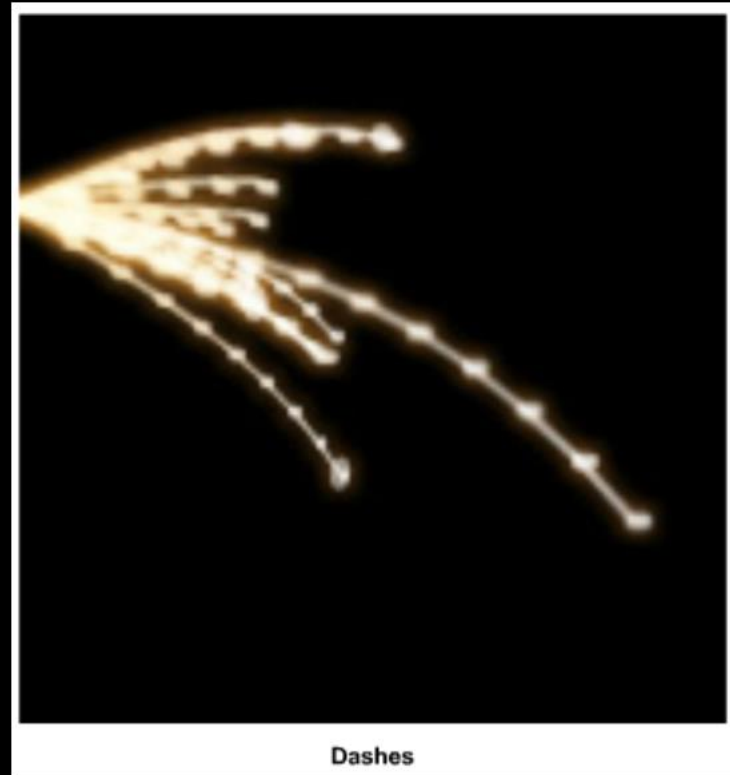

## Appendages

Appendages are offsets from the tip of the carrier line.

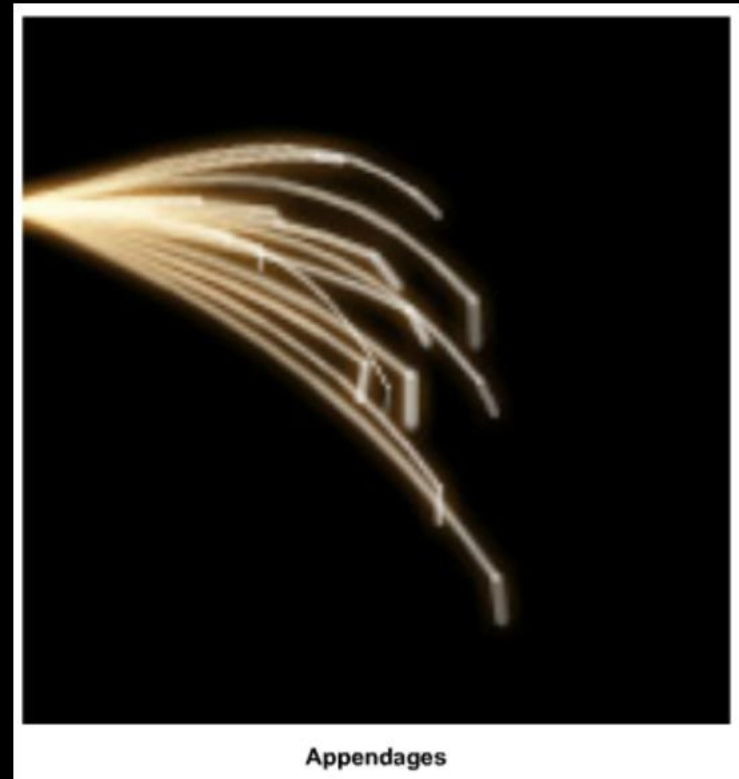

## Conducting the Spark Test

One big advantage of this test is that it can be applied to metal in all stages - bar stock in racks, machined forgings, or finished parts.

The spark test is best conducted by holding the steel stationary and touching a high speed portable grinder to the specimen with sufficient pressure to throw a horizontal spark stream about 12.00 in. (30.48 cm) long and at right angles to the line of vision.

Wheel pressure against the work is important because increasing pressure will raise the temperature of the spark stream and give the appearance of higher carbon content.

The sparks near and around the wheel, the middle of the spark stream, and the reaction of incandescent particles at the end of the spark stream should be observed.

## **Spark stream for low carbon steels**

Low-carbon steel has a long spark stream (about 70 inches normally), and its volume is moderately large, while in high-carbon steel, the stream is shorter (about 55 inches) and larger in volume.

The few sparklers that may occur at any place in low-carbon steel are forked, while in high-carbon steel the sparklers are small and repeating, and some of the shafts may be forked. Both will produce a white spark stream.

## **Spark stream for white cast iron**

White cast iron produces a spark stream approximately 20 inches in length.

The volume of sparks is small with many small and repeating sparklers.

The color of the spark stream close to the wheel is red, while the outer end of the stream is straw colored.



## **Spark stream for gray cast iron**

The malleable iron spark test will produce a spark stream about 30 inches in length.

It is of a moderate volume with many small, repeating sparklers toward the end of the stream. The entire stream is straw colored.

## **Spark stream for malleable iron**

The malleable iron spark test will produce a spark stream about 30 inches in length.

It is of a moderate volume with many small, repeating sparklers toward the end of the stream. The entire stream is straw colored.

## **Spark test for wrought iron**

The wrought iron spark test produces a spark stream about 65 inches in length. The stream is of large volume with few sparklers.

The sparklers show up toward the end of the stream and are forked. The stream next to the grinding wheel is straw colored, while the outer end of the stream is a bright red.

## **Spark test for stainless steel**

Stainless steel produces a spark stream approximately 50 inches in length, of moderate volume, with few sparklers. The sparklers are forked. The stream next to the wheel is straw colored. The sparks form wavy streaks with no sparklers.

## **Spark test for Monel metal**

Monel metal forms a spark stream almost identical to that of nickel and must be identified by other means.

## **Chip or chisel test**

The chip test or chisel test may also be used to identify metals.

The only tools required are a hammer and a cold chisel.

Use the cold chisel to hammer on the edge or corner of the material being examined.

The ease of producing a chip is the indication of the hardness of the metal. If the chip is continuous, it is indicative of a ductile metal, whereas if chips break apart, it indicates a brittle material.

## Metal ID by chip characteristics

On such materials as aluminium, mild steel, and malleable iron, the chips are continuous.

They are easily chipped and the chips do not tend to break apart.

The chips for gray cast iron are so brittle that they become small, broken fragments.

On high-carbon steel, the chips are hard to obtain because of the hardness of the material, but can be continuous.

Information given in Table 1-5 can help you identify various metals by the chip test.

Table 1-5 — Metal Identification by Chip Test.

Metals	Chip characteristics
White cast iron	Chips are small brittle fragments. Chipped surfaces are not smooth.
Gray cast iron	Chips are about 1/8 inch in length. Metal not easily chipped; chips break off and prevent smooth cut.
Malleable iron	Chips vary from 1/4 to 3/8 inch in length. Metal is tough and hard to chip.
Wrought iron	Chips have smooth edges. Metal is easily cut or chipped, and a chip can be made as a continuous strip.
Low-carbon and cast steel	Chips have smooth edges. Metal is easily cut or chipped, and a chip can be taken off as a continuous strip.
High-carbon steel	Chips show a fine grain structure. Edges of chips are lighter in color than chips of low-carbon steel. Metal is hard, but can be chipped in a continuous strip.
Copper	Chips are smooth, with sawtooth edges where cut. Metal is easily cut as a continuous strip.
Brass and bronze	Chips are smooth, with sawtooth edges. These metals are easily cut, but chips are more brittle than chips of copper. Continuous strip is not easily cut.
Aluminum and aluminum alloys	Chips are smooth, with sawtooth edges. A chip can be cut as a continuous strip.
Monel	Chips have smooth edges. Continuous strip can be cut. Metal chips easily.
Nickel	Chips have smooth edges. Continuous strip can be cut. Metal chips easily.
Lead	Chips of any shape may be obtained.

## Magnetic test

The magnetic test can be quickly performed using a small pocket magnet.

With experience, it is possible to judge a strongly magnetic material from a slightly magnetic material.

The nonmagnetic materials are easily recognized.

Strongly magnetic materials include the carbon and low-alloy steels, iron alloys, pure nickel, and martensitic stainless steels.

A slightly magnetic reaction is obtained from Monel and high nickel alloys and the stainless steel of the 18 chrome-8 nickel type when cold worked, such as in a seamless tube.

Nonmagnetic materials include copper-base alloys, aluminium-base alloys, zinc-base alloys, annealed 18 chrome-8 nickel stainless, magnesium, and the precious metals.





## Summary

This course provided a brief introductory overview and history of metallurgy, as well as how to identify the various metals and alloys, and their properties. Types of ferrous and nonferrous metals were briefly explored, along with mechanical and strength characteristics of metals and alloyed substances.

You also learned of corrosion resistance and metalworking processes, plus the use of simple tests to help identify common metals.

It was beyond the scope of this brief overview course to describe in full the many aspects of metallurgy.

Topics such as dislocation theory, plastic deformation, crystalline, amorphous and polycrystalline structure, metal fatigue, creep and stress rupture, residual stresses, brittle failure, and more were excluded.

This concludes our course on “Basic Principles of Metallurgy and Metalworking”.  
You may now proceed to the final exam.

**Thank you for taking this Flashcard course!**

*Basic Principles of Metallurgy and Metalworking, 2019 Edition*

*First Printing: March, 2019*

*Copyright © 2019 by Don Parnell, PE*

*All rights reserved. No part of this courseware may be reproduced or distributed, or transmitted in any form or by any means, including, without limitation, electronic, optical, or mechanical means (by way of example and not limitation, photocopying, or recording by or in an information storage retrieval system) without express written permission of the above mentioned courseware developers.*